

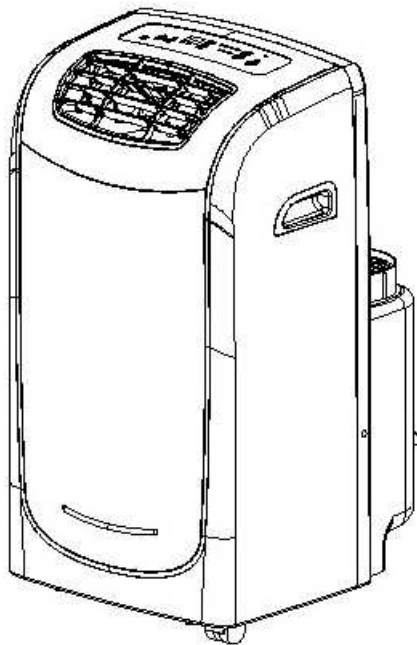

PORTABLE AIR CONDITIONER
DUAL-HOSE SYSTEM



WA-1150DE: 11,000 BTU

WA-1350DE: 13,000 BTU

Read this Manual

Inside you will find many helpful hints on how to use and maintain your air conditioner properly. Just a little preventive care on your part can save you a great deal of time and money over the life of your air conditioner. You'll find many answers to common problems in the chart of troubleshooting tips. If you review our chart of Troubleshooting Tips first, you may not need to call for service at all.



CAUTION

- Contact the authorized service technician for repair or maintenance of this unit.
- Contact the installer for installation of this unit.
- The air conditioner is not intended for use by young children or infirm persons without supervision.
- Young children should be supervised to ensure that they do not play with the air conditioner.
- If the power cord is to be replaced, replacement work shall be performed by authorized personnel only.
- Installation work must be performed in accordance with the national wiring standards by authorized personnel only.

CONTENTS

SOCIAL REMARK	
Social remark	2
SPECIFICATIONS	
Specifications	2
Operating Conditions	2
SAFETY PRECAUTIONS	
Safety rules	3
Electrical information	4
PARTS IDENTIFICATION	
Accessories	5
Tools needed for window kit installation	5
Front & Back of unit	6
AIR CONDITIONER FEATURES	
Control Panel	7
Operating Instructions	8
INSTALLATION INSTRUCTIONS	
Location	9
Window Kit Installation	10
Exhaust Hose Installation	11
CARE AND MAINTENANCE	
Care and Maintenance	12
TROUBLESHOOTING TIPS	
Trouble Shooting	13
Error Codes	13
Energy Saving Tips	13
REMOTE CONTROLLER	
Handling the Remote	14
Function buttons	15
Display Panel	16
Using the Remote	17
WARRANTY	
Your Guarantee	18

SOCIAL REMARK

Disposal: Do not dispose this product as unsorted municipal waste. Collection of such waste separately for special treatment is necessary.



Dispose packaging materials, such as plastic and carton, in the appropriate waste bins.

When this product reaches the end of its useful life, do not dispose with general household waste. For the correct collection and treatment of this product, take them to the collection point for reuse of electrical and electronic equipment. Contact your local authority for the appropriate collection point in your neighborhood.

SPECIFICATIONS

Model no.	WA-1150DE	WA-1350DE
Cooling capacity	11,000 BTU/hr	13,000 BTU/hr
Power consumption	1120W	1340W
EER	8.9	8.9
Air volume (max. speed)	434m ³ /h	390m ³ /h
Noise level (H/L)	55/49	58.5/53
Humidity removal capacity	1.1 L/hr	1.2 L/hr
Power supply	115V/60Hz/1phase	
Compressor	rotary	
Recommended room size	270 sq.ft.	320 sq.ft.
Refrigerant	R410A	
Fan speed	3	
Timer	0.5 ~ 24 hours	
Thermostat	62 ~ 88°F	
Operating temperature (cool)	62 ~ 95°F	
Operating temperature (dry)	54 ~ 95°F	
Exhaust pipe	59 inches max length	
Net / Gross Weight	79.37 / 94.8 lbs	84.88 / 98.11 lbs
Unit Dimension	18.11 x 20.39 x 33.07 inches	
Package Dimension	20.79 x 23.62 x 34.84	

* Data may vary for technical reasons; for greater precision, please refer to the rating label located on the back of the unit.

Operating Conditions

The air conditioner must be operated within the temperature range indicated below:

MODE	ROOM TEMPERATURE
COOL	17 ~ 35°C / 62 ~ 95°F
DRY	13 ~ 35°C / 55 ~ 95°F

SAFETY PRECAUTIONS

Safety rules

To prevent injury to the user or other people and property damage, the following instructions must be followed. Incorrect operation due to ignoring of instructions may cause harm or damage.

- Your air conditioner should be used in such a way that it is protected from moisture, e.g. condensation, splashed water, etc. Do not place or store your air conditioner where it can fall or be pulled into water or any other liquid. Unplug unit immediately if it occurs.
- Always transport your air conditioner in a vertical position and stand on a stable, level surface during use.
- Turn off the product when not in use.
- Always contact a qualified person to carry out repairs. If the supply cord is damaged, it must be repaired by a qualified electrician.
- Keep a clearance of at least 12 inches around the unit for proper air flow.
- If the air conditioner is knocked over during use, turnoff the unit and unplug immediately.
- Turn off and unplug the machine when it will not be used for an extended period of time.
- Never leave the appliance unsupervised when in operation.
- Do not store or use gasoline or other flammable vapours and liquids within the vicinity of this or any other appliance.
- Avoid fire hazard or electric shock. Do not use an extension cord or an adaptor plug. Do not remove any prong from the power cord.

Caution

- Do not operate your machine in a wet room such as a bathroom or laundry room.
- Do not touch the unit with wet or damp hands or when barefoot.
- Do not press the buttons on the control panel with anything other than your fingers.
- Do not remove any fixed covers. Never use this appliance if it is not working properly, or if it has been dropped or damaged.
- When unit is not in good order, please use common sense to prevent further damage to surroundings.
- All clean up is operator's responsibility.
- The manufacturer is not responsible for damages caused by improper use or non-observance of this instruction manual.
- If there is water leakage, clean up must be taken immediately.
- Never use the plug to start or stop the machine.
- Do not cover or obstruct the inlet or outlet grilles.
- Do not use hazardous chemicals to clean or come into contact with the unit. Do not use the unit in the presence of inflammable substances or vapour such as alcohol, insecticides, petrol, etc.
- Do not allow children to operate the unit unsupervised.
- Do not use this product for functions other than those described in the instruction manual.
- To prolong the life of the compressor, after powering off the unit, please wait at least 3 minutes before turning it back on.

WARNING! Electrical Information

- Be sure the electrical service is adequate for the model you have chosen. This information can be found on the serial plate, which is located on the side of the cabinet or back of unit.
- Be sure the air conditioner is properly grounded. To minimize shock and fire hazards, proper grounding is important. The power cord is equipped with a three-prong grounding plug for protection against shock hazards.
- Your air conditioner must be used in a properly grounded wall receptacle. If the wall receptacle you intend to use is not adequately grounded or protected by a time delay fuse or circuit breaker, have a qualified electrician install the proper receptacle.
- Ensure the receptacle is within accessibility range after unit installation.

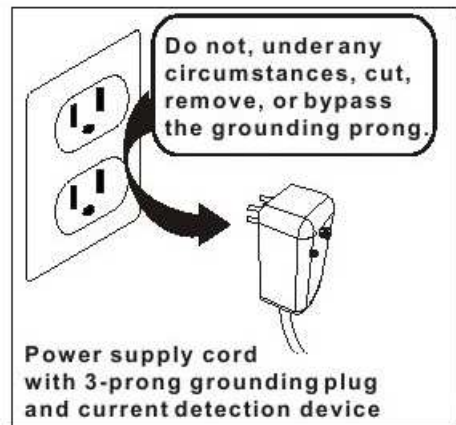

Operation of Current Device

The power supply cord contains a current device that senses damage to the power cord. To test your power supply cord, do the following:

1. Plug in the Air Conditioner.
2. The power supply cord will have TWO buttons on the plug head. Press the TEST button, you will notice a click and the RESET button pops out.
3. Press the RESET button to engage, there will be another click.
4. The power supply cord is now supplying electricity to the unit.

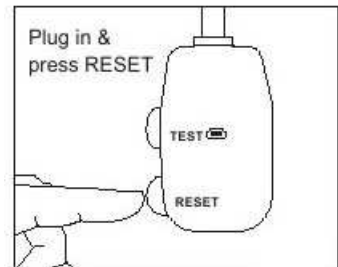





NOTE: Some plugs have buttons on the top.

Notes:

- Do not use this device to turn the unit on or off.
- Always make sure the RESET button is pushed in for correct operation.
- The power supply must be replaced if it fails to reset when the TEST button is pushed; or when it cannot be reset. Please contact Sunpentown.
- If the power supply cord is damaged, it cannot be repaired, please contact Sunpentown.

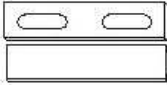
PARTS IDENTIFICATION

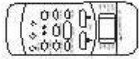
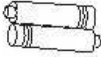
PARTS :	PARTS NAME :	QUANTITY :
	Exhaust hose with adaptor	2/set
	Window Exhaust Adaptor B	2pcs
	Window Slider Kit	1 set
	Foam seal	3pcs
	Remote Controller (For remote control models only)	1pc
	Battery(For remote controller)	2pcs

Check all accessories are included in the package. Refer to the installation instructions for usage.
 Note: all illustrations in this manual are for explanation purposes only. The actual unit and parts may be slightly different. The actual shape shall prevail

Suggested tools for window kit installation

- Medium-sized Phillips screwdriver
- Tape measure or ruler
- Knife or scissors
- Saw (in the event that the window kit needs to be cut down in size)

Front

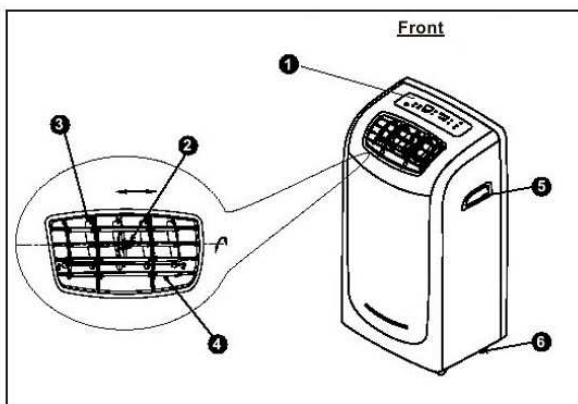

1. Control Panel
2. Blade Control Handle (adjust manually)
3. Vertical Louver Blade
4. Handle (both sides)
5. Remote Signal Receptor
6. Caster

Back

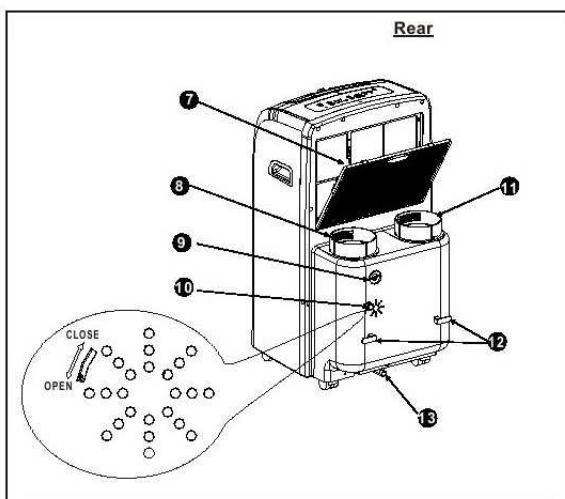

7. Air filter
8. Air Inlet
9. Drain Outlet
10. Vent Control
11. Air Outlet
12. Power Cord Hooks (for storage)
13. Bottom Drain Outlet

AIR CONDITIONER FEATURES

Before you begin, thoroughly familiarize yourself with the control panel and remote controller and the functions.

The unit can be controlled by either the control panel or remote controller.

CONTROL PANEL

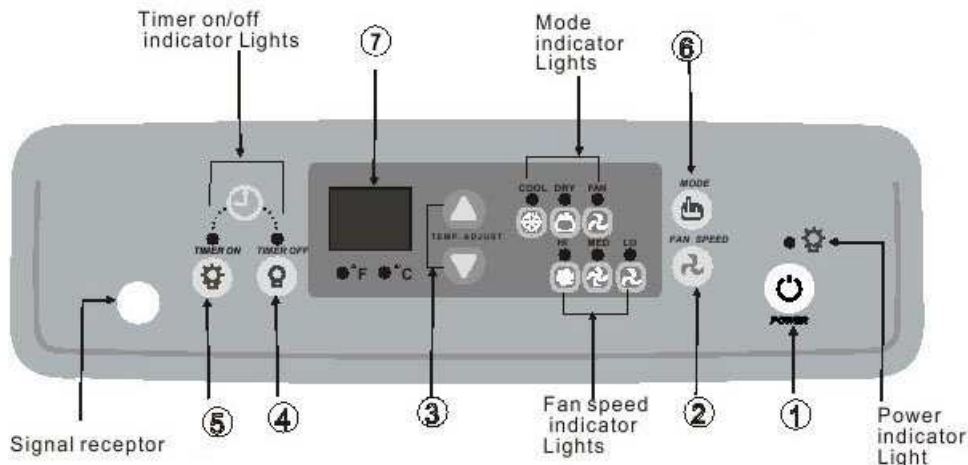

- 1. POWER button**
Press to turn unit ON or OFF
- 2. FAN SPEED button**
Press to select HIGH, MED or LOW fan speed. The corresponding speed indicator will illuminate
- 3. UP (▲) and DOWN (▼) buttons**
 - To increase or decrease temperature setting (17-30°C/62-88°F): each press is increment of 1°C or 2°F.
 - To set TIMER (0-24 hrs)
 - Press and hold both buttons for 3 seconds to change display from degrees Fahrenheit to degrees Celsius, or vice versa
- 4. TIMER ON button**
Used to initiate or cancel the AUTO-ON program, corresponding indicator illuminates.
- 5. TIMER OFF button**
Used to initiate or cancel the AUTO-OFF program, corresponding indicator illuminates.
- 6. MODE select button**
Press to select the operating mode. Each press of the button will cycle through the sequence: COOL, DRY and FAN. The corresponding mode indicator will illuminate.
- 7. LED display**
 - Shows the set temperature in °C or °F and TIMER set ting
 - Shows error codes

OPERATING INSTRUCTIONS

COOL mode (operating temperature range: 17-35°C/62-95°F)

- Press the MODE button until the COOL indicator light illuminates.
- Press UP (∧) or DOWN (∨) buttons to set your desired room temperature. The temperature can be set within a range of 17-30°C / 62-88°F.
- Press the FAN SPEED button to select desired fan speed.

Note: When room temperature is 37°C/98°F or above, the fan speed is automatically controlled at low. Unit will resume to previous fan speed when room temperature falls below 35°C/93°F.

DRY mode (operating temperature range: 13-35°C/54-95°F)

- Press the MODE button until the DRY indicator light illuminates.
- Under this mode, you cannot select a fan speed or adjust the temperature. Fan is on LOW.
- Keep windows and doors closed for best dehumidifying effect.
- Do not attach duct to window.

FAN mode

- Press the MODE button until the FAN indicator light illuminates.
- Press the FAN SPEED button to select speed. Temperature cannot be adjusted.
- Do not attach duct to window.

AUTO mode

- AUTO operation can only be set by the remote controller. Refer to instructions on page 17.

TIMER operation

Setting the ON timer:

- Press the TIMER ON button when unit is off.
- Press the UP (∧) or DOWN (∨) button to select the time you want to start operating the unit.

Setting the OFF timer:

- Press the TIMER OFF button when unit is operating.
- Press the UP (∧) or DOWN (∨) button to select the time you want the unit to stop operation.

Note:

- The timer is adjustable from 0.0 to 24
- The time is programmed as: 0.5, 1.0, 1.5, 2.0, 2.5, 3.0, 3.5, 4.0, 4.5, 5.0, 5.5, 6.0, 6.5, 7.0, 7.5, 8.0, 8.5, 9.0, 9.5, 10, 11, 12, 13, 14, 15, 16, 17, 18, 19, 20, 21, 22, 23, 24, 0.0.
- The time will register after 5 seconds of releasing the (∧) or (∨) button. Continue pressing until the desired time is established. Once the time is registered and change is needed, you must repeat the steps.

Auto-Restart

If unit breaks off unexpectedly due to power failure, unit automatically restarts at previous setting when power resumes. If power is resumed in less than 3 minutes, unit will auto-start after a 3 minutes delay – this is a safety feature to protect the unit.

Air Flow Direction Adjustment

The louver can be manually adjusted to desired position, but keep louver fully opened during operation.

INSTALLATION INSTRUCTIONS

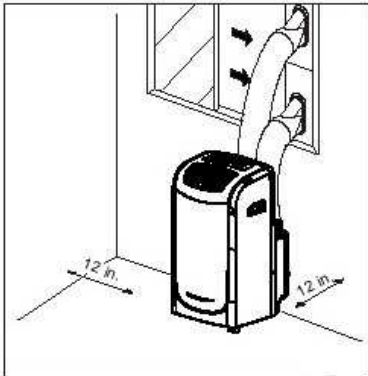

Fig.1

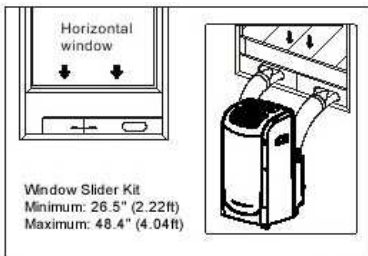

Fig.2



Fig.3

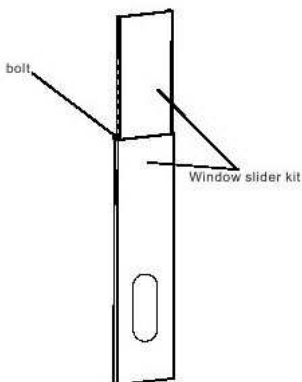

Fig.4

Location

- The air conditioner should be placed on a firm foundation to minimize noise and vibration. For safe and secure positioning, place the unit on a smooth, level floor strong enough to support the unit.
- The unit has casters to aid placement, but it should only be rolled on smooth and flat surfaces. Use caution when rolling on carpet. Do not attempt to roll the unit over objects.
- The unit must be placed within reach of a properly rated grounded socket.
- Never place any obstacles around the air inlet or outlet.
- Allow at least 30cm (approx 12 inches) of space from the wall for efficient airflow. (Fig.1)

Window Kit Installation

Your window slider kit is designed to fit most standard "vertical" and "horizontal" window applications.

However, it may be necessary for you to improve or modify some aspects of the installation procedures for certain types of windows. Please refer to Fig.2 and Fig.3 for minimum and maximum window openings. Window slider kit can be fixed with a small bolt (Fig.4)

Note: If the window opening is less than the mentioned minimum length of the window slider kit, cut the piece with holes on its side to fit your window opening. Do not cut the piece with the exhaust adapter opening.

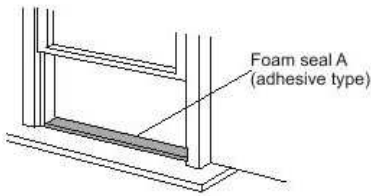

Fig.5

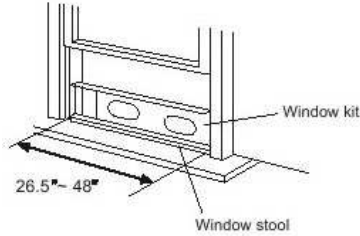

Fig.6

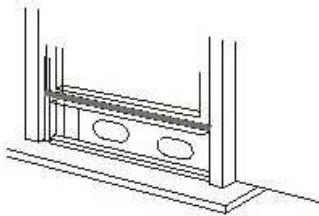

Fig.7

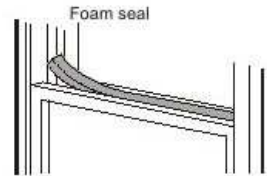

Fig.8

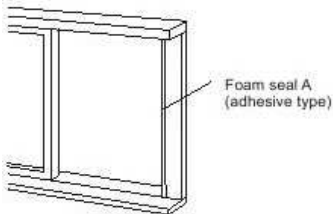

Fig.9

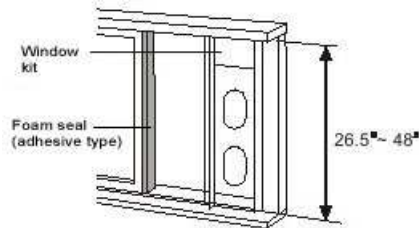

Fig.10

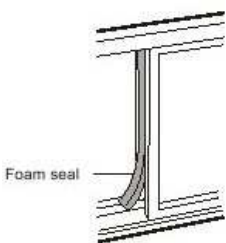

Fig.11

Installation in a double-hung sash window

1. Trim foam seal (adhesive type) to the proper length and attach to window stool. (Fig.5)
2. Adjust the length of the slider kit according to the width of window. Attach window slider kit to window stool, on top of foam seal. (Fig.6)
3. Trim the foam seal (adhesive type) to the proper length and place on top of the slider kit. (Fig.7)
4. Close window sash securely against window.
5. Trim the last foam seal to the proper length to seal the open gap between the top window sash and outer window sash. (Fig.8)

Installation in a double-hung sash window

1. Trim foam seal (adhesive type) to the proper length and attach to window frame. (Fig.9)
2. Adjust the length of the slider kit according to the height of window. Attach window slider kit against foam seal. Trim other foam seal (adhesive type) to the proper length and attach to open side of window kit (or side of window) (Fig.10)
3. Slide window close against slider kit.
4. Trim the last foam seal to the proper length to seal the open gap between the two window sashes. (Fig.11)

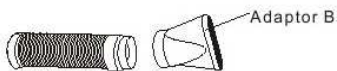
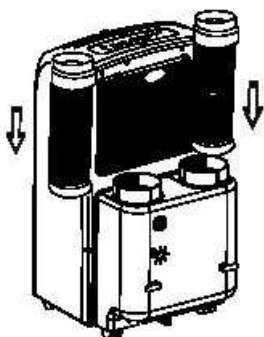

Fig.12

Fig.13

Exhaust hose installation:

Install or remove the exhaust according to usage mode:

COOL or AUTO mode	Install
FAN or DRY mode	Remove

1. Install the exhaust hose to unit as depicted in Fig.12.
2. Install the exhaust adaptor to the hose as shown in Fig.13. Refer to previous pages for window kit installation.

IMPORTANT

KEEP CURVE OF EXHAUST HOSE SMOOTH, WITHOUT ANY KINKS OR SHARP BENDS.

VENT CONTROL feature

The Vent Control is located on the back of the unit:

- OPEN position: removes stale air from the room and exhausts it to the outside. Fresh air is drawn in through normal passages in the home
- CLOSE position: no air circulation.

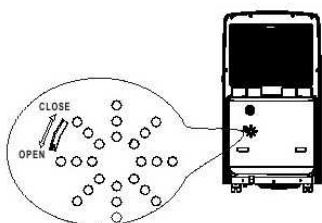

Fig.14

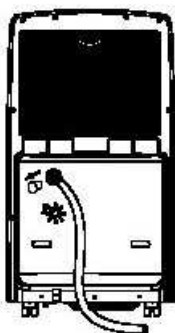

Fig.15

Continuous Water Drainage:

- Remove drain plug from back of unit. Attach drain hose to the opening. Direct other end of hose directly over drain area. (Fig.15)
- This is recommended when running the unit in DRY mode.
- Not recommended to use with COOL mode; the cooling efficiency will actually be reduced.

Note: Make sure the connection between the hose and unit is tight and without leak.

Emptying the bottom water tray

When the water level of the built-in bottom tray reaches a predetermined level, the panel displays "P1". At this time the Cooling or Dehumidifying process will immediately stop. However, the fan motor will continue to operate. Carefully move the unit to a drain location (or have a container placed under the spout), remove the bottom drain plug and let water flow out. Restart the machine and "P1" symbol should disappear. If the error persists, call for service.
 Note: be sure to replace the bottom drain plug before restarting the unit.

CARE AND MAINTENANCE

IMPORTANT

- Be sure to power off and unplug the unit before cleaning or servicing.
- Do not use gasoline, thinner or other chemicals to clean the unit
- Do not wash the unit directly under a tap or use a hose. May cause electrical danger.
- If the power cord is damaged, contact Sunpentown.



Fig.16

Air Filter

Clean the air filter at least once every two weeks to prevent inferior fan operation due to dust.

- Removal: Grasp the air filter tab and first pull towards you, then lift upwards. Fig.17
- Cleaning: Wash the filters by immersing gently in warm water (about 40°C/104F) with a neutral detergent. Rinse thoroughly and dry completely in a shady place.
- Replace filter.



Fig.17

Housing

Use a lint-free cloth soaked with neutral detergent to clean the housing. Followed by a dry clean cloth.

Storage

- Remove the rubber plug at the back of unit and attach a hose to drain outlet. Place the open end of the hose directly over drain area; or have a container placed under the spout. Allow water to drain out. (Fig.18)
- Run the unit in FAN mode for half a day in a warm room to dry the inside of the unit. This will prevent mold from forming.
- Power off and unplug from power source. Wrap power cord and secure with tape. (Fig.19)
- Remove batteries from the remote controller.
- Clean air filters and reinstall.
- Disconnect exhaust hose, keep in safe place.

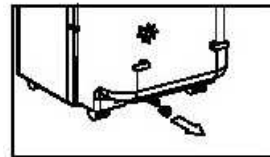

Fig.18

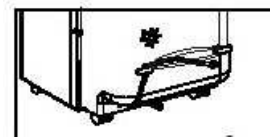

Fig.19

TROUBLESHOOTING TIPS

PROBLEM	POSSIBLE CAUSES	SUGGESTED REMEDIES
Unit does not start after Power button is pressed	P1 error code is displayed.	Drain water in bottom tray.
	Room temperature is lower than the set temperature (in Cooling mode).	Set temperature to a lower setting.
Not cool enough	The windows or doors in the room are not closed.	Please close all windows and doors.
	There are heat sources in the room.	Remove the heat source, if possible.
	Exhaust air duct is not connected or blocked.	Connect the duct and make sure it is without sharp bends.
	Temperature setting is too high.	Lower the set temperature.
	Air filter is blocked by dust.	Clean the air filter.
Noisy or vibration	The ground is not level or uneven.	If possible, move unit to a flat and even surface.
Gurgling sound	This is sound from the flowing of refrigerant inside the unit.	This is normal.

Error Codes:

E1 – Evaporator temperature sensor error.

Unplug the unit and plug it back in. If error repeats, contact Sunpentown Customer Service.

E2 – Room temperature sensor error.

Unplug the unit and plug it back in. If error repeats, contact Sunpentown Customer Service.

Protection codes:

P1 – Bottom water tray is full. Drain according to instructions found on page .

Energy Saving Tips

- Use the unit in the recommended room size.
- Locate the unit where furniture cannot obstruct the airflow.
- Keep blinds/curtains closed during the sunniest part of the day.
- Keep the filters clean.
- Keep doors and windows closed to keep cool air in and warm air out.
- If a very hot day is expected, turn on the unit early to keep the room cool and keep the heat out.

REMOTE CONTROLLER

Handling the remote controller

Use the remote within a distance of 26 ft from the appliance, pointing it towards the receiver. Reception is confirmed by a beep.



CAUTION

- Be sure there are no barriers between the remote and the unit's receiver (i.e. curtains, doors or other obstacles). Otherwise the AC unit will not respond.
- Prevent spilling of any liquid onto the remote controller.
- Do not expose the remote to direct sunlight or heat.
- If the infrared signal receiver on the unit is exposed to direct sunlight, the air conditioner may not respond properly. Use curtains to black the sunlight.
- Keep controller away from EMI (Electro-Magnetic Interference) supplied by other household appliances.

Replacing batteries

The remote controller is powered by (2) AAA batteries, housed in the back of remote and protected by a cover.

1. Remove the cover by pressing down and sliding off.
2. Remove the old batteries and insert the new batteries, placing the (+) and (-) ends correctly.
3. Replace the cover and sliding it back into position.

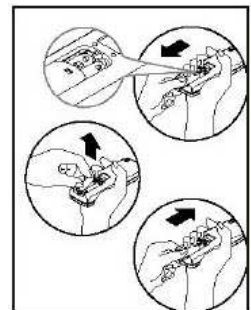

NOTE: When the batteries are removed, all programming will be erased. After inserting the new batteries, the remote can be reprogrammed.

CAUTION

- Do not mix old and new batteries or batteries of a different type.
- Remove batteries if the remote will not be used for an extended period of time (more than 1 month).
- Dispose old batteries in special containers.

Function buttons

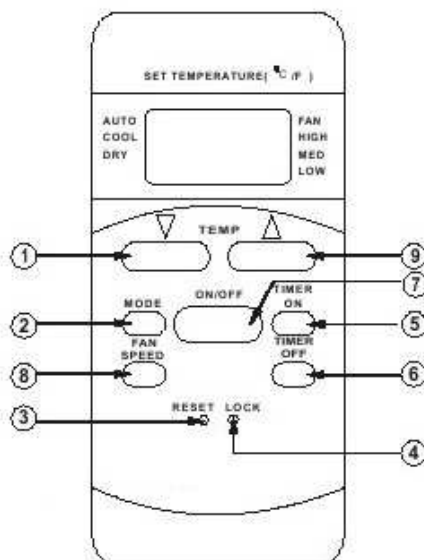

1. TEMP DOWN button

Press to decrease set temperature by 1°C (2°F) increments to 17°C (62°F)

2. MODE button

Press to select operation mode: AUTO→COOL→DRY→FAN

3. RESET button

Once the recessed RESET button is pressed, all settings will be cancelled and controller will return to default settings.

4. LOCK button

Press to lock current settings and prevent accidental changes. Press again to unlock. Once locked, remote will not accept any operations except that of LOCK. A lock symbol will appear on the remote's display.

5. TIMER ON button

Press to activate the Auto-on timer setting.

6. TIMER OFF button

Press to activate the Auto-off timer setting.

7. ON/OFF button

Press to power on or power off the unit

8. FAN SPEED button

Press to select fan speed: AUTO→LOW→MED→HIGH

9. TEMP UP button

Press to increase set temperature by 1°C (2°F) increments to 30°C (88°F)

Display Panel

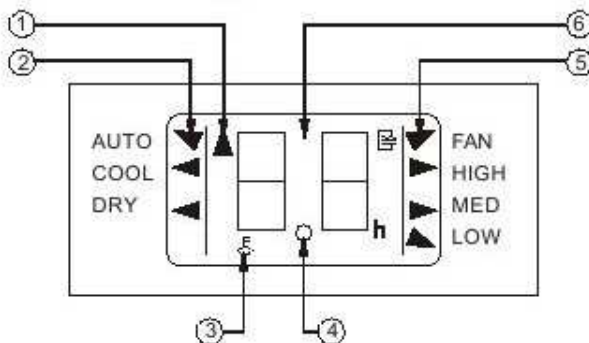

1. TRANSMISSION indicator

Indication that remote is transmitting signal to the AC unit.

2. MODE display

Displays the current operation mode: AUTO, COOL, DRY or FAN.

3. LOCK indicator

Symbol is displayed when the Lock button is pressed.

4. TIMER Display

This display area shows any TIMER setting:

- TIMER ON: Auto-On timer is set
- TIMER OFF: Auto-Off timer is set
- TIMER ON OFF: Both Auto-On and Auto-Off are set

5. FAN Display

Displays the selected fan speed: HIGH, MED or LOW. If AUTO is selected, no indicators are displayed. When unit is operating under AUTO or DRY mode, no indicators are displayed.

6. LCD Panel

Displays set temperature (17-30°C / 62-88°F) and Timer setting (0-24h). If FAN mode is selected, there will be no display.

NOTE: All symbols are depicted in the figure above for the purpose of clear presentation. During the actual operation, only the relative functional items will display on the panel.

Using the Remote Controller

AUTO operation

With the AC unit plugged in:

1. Press the MODE button to select Auto.
2. Press the TEMP button to set desired temperature, between 21-28°C / 70-84°F. Each press is an increment of 1°C (2°F).
3. Press the ON/OFF button to start the AC unit.

NOTE:

- Under Auto mode, the AC unit automatically chooses the operating mode (COOL, FAN or DRY), by sensing the difference between the ambient temperature and set temperature on the remote controller.
- In Auto mode, the fan speed is automatically set and cannot be changed. There will be no indicators shown on the display panel.
- If Auto mode is not comfortable for you, switch to COOL mode.

COOL / FAN operation

With the AC unit plugged in:

1. Press the MODE button to select Cool or Fan mode.
2. Press the TEMP button to set desired temperature, between 17-30°C / 62-88°F. Each press is an increment of 1°C (2°F).
3. Press the FAN SPEED button to select fan speed.
4. Press the ON/OFF button to start the AC unit.

NOTE:

Under FAN mode, temperature cannot be set and thus, no temperature will be displayed. Only steps 1,3, and 4 may be performed.

DRY (dehumidifying) operation

With the AC unit plugged in:

1. Press the MODE button to select DRY mode.
2. Press the TEMP button to set desired temperature, between 21-28°C / 70-84°F. Each press is an increment of 1°C (2°F).
3. Press the ON/OFF button to start the AC unit.

NOTE: Under DRY mode, fan speed is automatically controlled.

TIMER operation

To set Auto-on timer:

1. Press the TIMER ON button and remote will display TIMER ON. The last Auto-on setting and the signal "h" will also be displayed.
2. Press the TIMER ON button again to set desired Auto-on timer. Keep pressing the button until the desired time has been reached.

To set Auto-off timer:

1. Press the TIMER OFF button and remote will display TIMER OFF. The last Auto-off setting and the signal "h" will also be displayed.
2. Press the TIMER OFF button again to set desired Auto-off timer. Keep pressing the button until the desired time has been reached.

After setting TIMER ON/OFF, there will be a one-half second delay before the remote transmits the signal to the AC unit. Then after approximated another 2 seconds, the signal "h" will disappear and the set temperature will re-appear on the LCD display.

NOTE: The setting time is relative time – time set is based on the delay of current time.



Your Guarantee

If this product is found to be faulty as a result of faulty materials or workmanship within one year from date of purchase, it will be repaired free of charge.

This guarantee is subject to the following terms:

- Sunpentown must be notified of the fault.
- Proof of purchase must be presented to Sunpentown's nominated representative.
- The warranty will be void if the product is modified, misused or repaired by an unauthorized person.
- The warranty after repair will not be extended beyond the original one-year period.
- All replacement parts will be new or reconditioned.
- Parts, which are replaced, become the property of Sunpentown.
- The warranty applies for the use of the product in the USA only.

What is NOT COVERED:

- Warranty does not include freight charges.
- Incidental or consequential damage caused by possible defects with this product.
- Damage to product caused by improper power supply voltage, accident, fire, floods or acts of nature.
- Failure of product resulting from unauthorized modifications to the product.
- Improper installation or failure to perform the necessary maintenance.

This GUARANTEE is in addition to your Statutory Rights

SUNPENTOWN INTERNATIONAL INC.
14625 Clark Ave. City of Industry, CA 91745
Tel: 800-330-0388
service@sunpentown.com
www.sunpentown.com